



Energy Recovery Ventilator  
**Operation Manual**

Models:

XHBQ-D2THA to XHBQ-D13THA

XHBQ-D1.5TPA to XHBQ-D20TPA

**Attention**

Please read this manual carefully before using the equipment





# Content



















Safety Considerations-----	3,4
Unit Specifications-----	5,6
Dimensioned Drawings-----	7,8
Installation Considerations-----	9,10,11
Electricity Installation -----	12
WiringDiagrams-----	13,14
Commissioning Information -----	15
Controller Operation -----	16,17
Maintenance -----	18

## Safety Precaution

Please read the following safety instructions before installation. And ensure that the unit is installed correctly.







Please observe all instruction in order to avoid any injury or damage to equipment or property.

<b>Safety attentions</b>			
The following symbols indicate potential levels of caution.			
 <b>Warning</b>	Situations with a risk or death or serious injure.	 <b>Attention</b>	Situations with a risk of injury or equipment/property damage.
The following symbols indicate compliance which must be observed			
	Not allowed or Stop		Must follow  or obliged

 <b>Warning</b>			
	Installation to be carried out by qualified person, End Users must not install, move or re-install this equipment by themselves		An anti-bird net or similar device should be installed to outside vents. Ensure there are no obstructions to or in the ducts
	Installation engineers must follow this manual strictly. Improper action can create a health hazard and reduce efficiency of the unit		Fresh air vent must be far enough away from any flue gas discharge or areas where hazardous vapors are present
	Unit must be installed strictly following this manual and mounted to a weight bearing surface for the weight of the unit		Electric engineering must follow national regulations and the manual, use special cables. Less capacity cables and improper engineering can cause electric shock or fire.
	During maintenance or repair, the unit and circuit breaker must be switched off. Otherwise electric shock could occur.		Ground wire cannot be connected to gas pipe, water pipe, lighting rod or telephone line etc. Incorrect grounding can cause electric shock.
 <b>Attention</b>			
	Power cable and wires must be installed by a qualified electrical engineer. Improper connection can cause over heating. Fire and loss of efficiency.		To avoid condensation, insulation should be fitted to fresh air ducts. Other ducting may also require insulation depending on dew point conditions.
	Insulation between the metal ducting and wall penetration must be installed if the ducting penetrates metal wall cladding, to avoid risk of electric shock or current leakage.		The cover of wiring box must be pressed down and closed to avoid dust and dirt entering. Excess dust and dirt can cause over-heating of terminals and result in fire or electric shock.
	Use only approved installation hardware and accessories. Failure to observe can result in fire risk, electric shock and equipment failure		Where the unit is positioned, at high level in a hot humid situation. Please ensure sufficient ventilation is available
	The outdoor ducts must be installed facing downwards to avoid rain water entering. Improper installation can cause water leakage.		Correctly sized MCB must be fitted to the unit suitable earth leakage protection should also be installed to avoid risk of electric shock or fire.

## Safety Precaution

### Safety Considerations

 <b>Attention</b>			
	Do not install the unit in an extremely humid conditions, as it may result in electric shock and pose a fire risk.		Do not use the units as the primary kitchen extract grease and fatty deposits can block the heat exchanger, filter and pose a fire risk.
	Don not install the unit in areas there any poisonous or caustic gases are present.		Do not install the unit near open flame as it may result in over heating and pose a fire risk
	Acidic or alkali environments can cause poisoning or a fire		Rated supply voltage must be maintained, otherwise this may cause fire.

# Specifications

Model		XHBQ-D2THA	XHBQ-D3THA	XHBQ-D4THA	XHBQ-D6THA	XHBQ-D8THA	XHBQ-D10THA	XHBQ-D13THA	
Airflow	(m3/h)	L	150	250	350	500	700	900	1000
		M	200	300	400	600	800	1000	1300
		H	200	300	400	600	800	1000	1300
External pressure	(Pa)	L	60	75	80	89	92	80	75
		M	70	82	85	92	96	85	85
		H	75	85	88	97	100	86	90
Enthalpy Eff.(%)	Cooling	L	60	62	62	63	57	60	58
		M	55	57	57	59	55	58	56
		H	55	57	57	59	5	58	56
	Heating	L	63	65	65	67	63	64	62
		M	59	61	60	61	57	62	59
		H	59	61	60	61	57	62	59
Temp.Eff.	%	L	75	73	74	76	74	76	76
		M	70	68	69	70	68	70	70
		H	70	68	69	70	68	70	70
Noise	dB(A)	L	22	23	25	25	32	32	37
		M	25	27	29	31	37	36	40
		H	27	30	32	35	39	40	42
Voltage (V)		220	220	220	220	220	220	220	
Current (A)		0.5	0.56	0.72	0.96	1.7	2.1	3.4	
Input Power (W)		105	117	150	200	355	440	710	
Net Weight (KG)		23	25	31	36	60	70	79	

# Specifications

Model		XHBQ-D1.5TPA	XHBQ-D2.5TPA	XHBQ-D3.5TPA	XHBQ-D5TPA	XHBQ-D6.5TPA	XHBQ-D8TPA	XHBQ-D10TPA	XHBQ-D15TPA	XHBQ-D20TPA	
Airflow	(m <sup>3</sup> /h)	L	115	165	270	360	515	625	780	1250	1700
		M	150	250	350	500	650	800	1000	1500	2000
		H	150	250	350	500	650	800	1000	1500	2000
External pressure	(Pa)	L	34	30	36	30	25	60	25	20	20
		M	58	70	60	60	40	98	35	45	25
		H	75	85	90	100	70	120	85	75	60
Enthalpy Eff.(%)	Cooling	L	67	67	67	68	64	68	68	68	68
		M	63	63	66	62	65	65	65	65	65
		H	63	63	66	62	62	65	65	65	65
	Heating	L	74	73	72	72	70	74	74	74	74
		M	70	70	69	67	68	71	71	71	71
		H	70	70	69	67	68	71	71	71	71
Temp.Eff.	%	L	77	77	77	78	77	77	77	77	77
		M	75	75	75	75	75	75	75	75	75
		H	75	75	75	75	75	75	75	75	75
Noise	dB(A)	L	22	22	25	25	30	32	31	31	34
		M	24	26	29	31	34	36	36	39	39
		H	26	27	31	33	35	38	38	41	41
Voltage (V)		220	220	220	220	220	220	220	220	220	
Current (A)		0.5	0.56	0.72	0.96	1.4	1.7	2.1	3.4	4.2	
Input Power (W)		105	117	150	200	295	355	440	710	880	
Net Weight (KG)		25	29	37	43	64	71	83	165	189	

# Dimensioned Drawings

## XHBQ-D2THA to D13THA Models

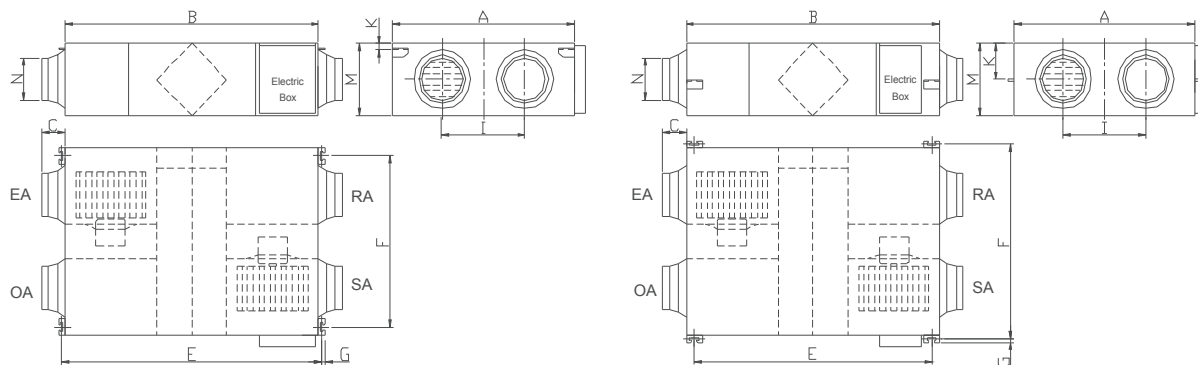

Model	A	B	C	E	F	G	I	K	M	N
XHBQ-D2THA	580	666	100	725	510	19	290	20	264	φ144
XHBQ-D3THA	599	744	100	675	657	19	315	111	270	Φ144
XHBQ-D4THA	804	744	100	675	862	19	480	111	270	Φ144
XHBQ-D6THA	904	824	107	754	960	19	500	111	270	φ194
XHBQ-D8THA	884	1116	85	1045	940	19	428	170	388	φ242
XHBQ-D10THA	1134	1116	85	1045	1190	19	678	170	388	φ242
XHBQ-D13THA	1134	1116	85	1045	1190	19	678	170	388	φ242

## XHBQ-D1.5TPA to D10TPA Models

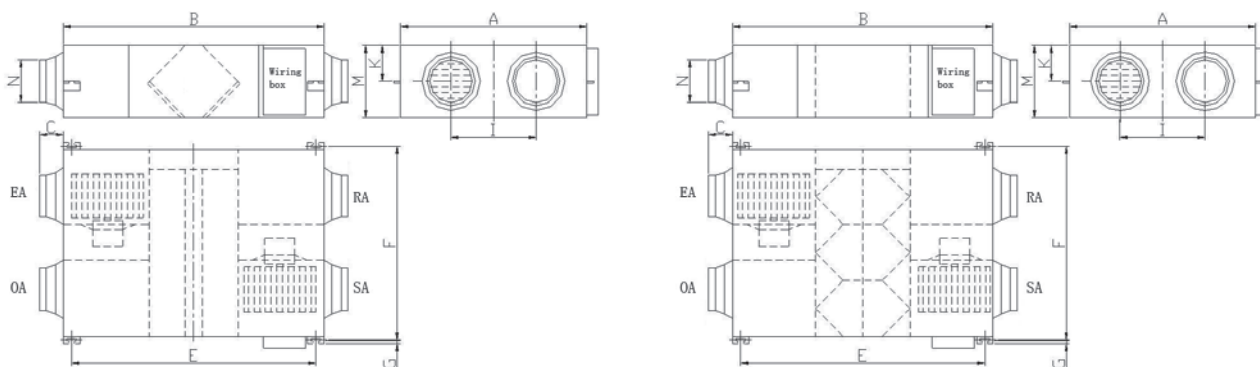

Model	A	B	C	E	F	G	I	K	M	N
XHBQ-D1.5TPA	580	808	100	867	510	19	290	20	264	Φ144
XHBQ-D2.5TPA	599	920	100	850	657	19	315	111	264	Φ144
XHBQ-D3.5TPA	804	882	100	813	860	19	480	111	270	Φ144
XHBQ-D5TPA	904	962	107	890	960	19	500	1111	270	Φ194
XHBQ-D6.5TPA	884	1222	107	1150	940	19	480	146	340	Φ194
XHBQ-D8TPA	884	1322	85	1250	940	19	428	170	388	Φ242
XHBQ-D10TPA	1134	1322	85	1250	1190	19	678	170	388	φ242

# Dimensioned Drawings

## XHBQ-D15TPA to D20TPA Models

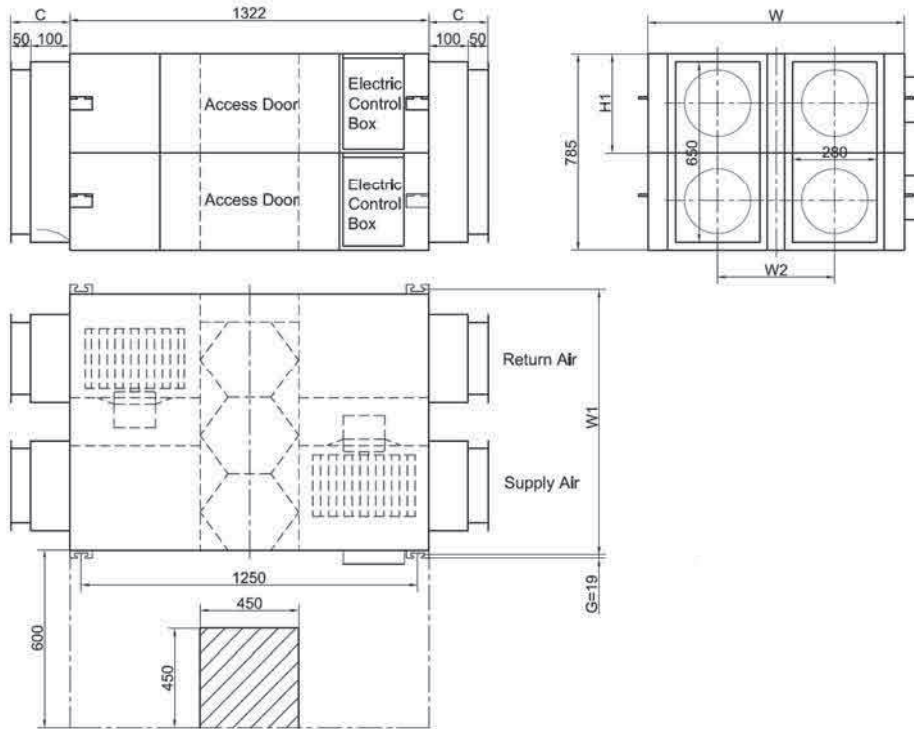

Model	L	L1	W	W1	W2	H	H1	C	G	Duct size
XHBQ-D15TPA	1322	1250	884	940	428	785	170	150	19	280*650
XHBQ-D20TPA	1322	1250	1134	1190	678	785	170	150	19	280*650



# Installation Considerations

## Installation Considerations

Protect the unit to avoid dust or other obstructions entering the unit and accessories during installation, or whilst in storage on site. Service ports should be installed to allow access for filter maintenance.

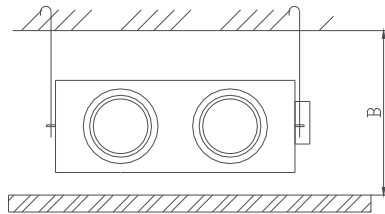
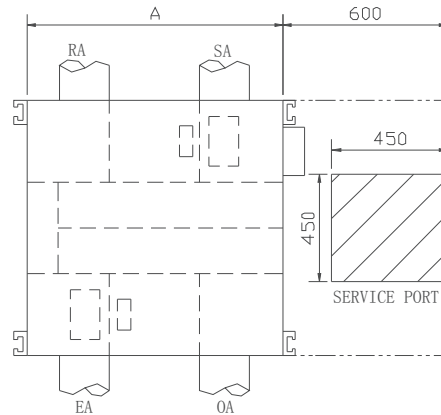
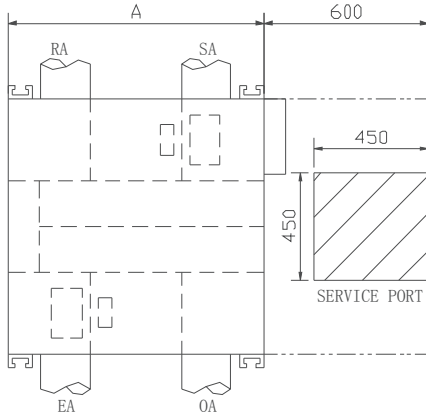

Model	A	Inner ceiling height B
XHBQ-D2THA	580	320
XHBQ-D1.5TPA	580	320

Model	A	Inner ceiling height B
XHBQ-D3THA	599	320
XHBQ-D4THA	804	320
XHBQ-D6THA	904	320
XHBQ-D8THA	884	450
XHBQ-D10THA	1134	450
XHBQ-D13THA	1134	450

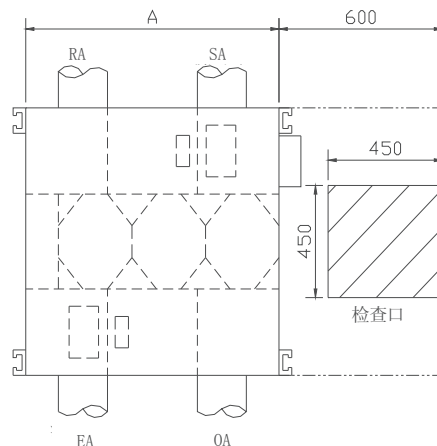
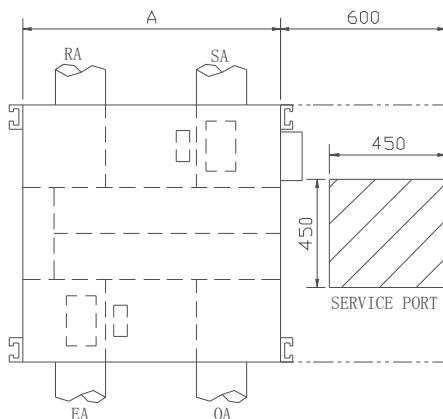

Model	A	Inner ceiling height B
XHBQ-D2.5TPA	599	320
XHBQ-D3.5TPA	804	320
XHBQ-D5TPA	904	320

Model	A	Inner ceiling height B
XHBQ-D6.5TPA	884	390
XHBQ-D8TPA	884	440
XHBQ-D10TPA	1134	440
XHBQ-D15TPA	884	835
XHBQ-D20TPA	1134	835

# Installation Considerations

## Installation Diagram

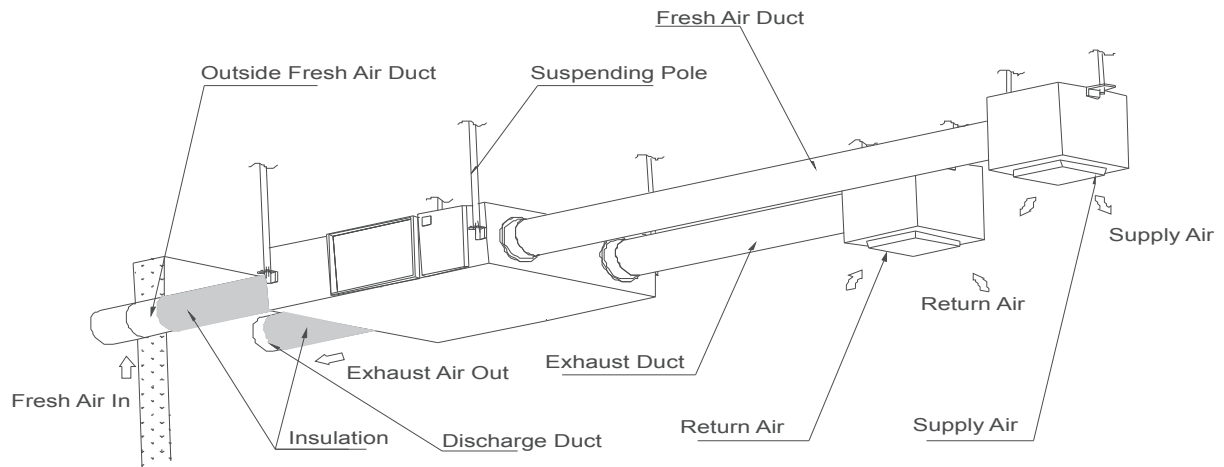

## Physical Installation

1. Installer to prepare suitable threaded hangers with adjustable nuts and gaskets.
2. Install as shown by the image above. Installation must be level and securely fastened.
3. Failure to observe proper fixing could result in injury, equipment damage and excessive vibration. Uneven installation will also effect damper operation.

Notes for reverse installation of the unit

4. Reverse labeling shows the unit is upside down.

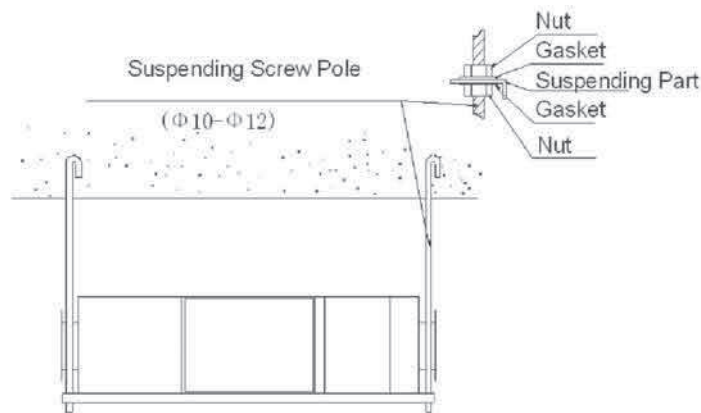

## Ducting

1. Connection of unit vents and ducts should be taped or sealed to prevent air leakage, and should comply to relevant guidelines and regulations.
2. The two outdoor vents should face downward toward the outside to prevent any rain water ingress. (angle 1/100 1/50).
3. Insulation must be with the two ducts outside to prevent condensation.

Material: glass cotton, Thickness: 25mm

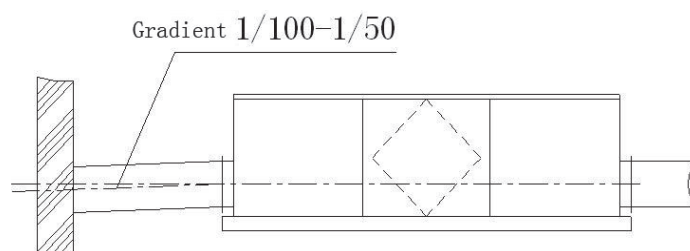

# Installation Considerations

1. Be sure the ceiling height is no less than the Figures in above table B column.
2. Unit must not be installed close to boiler flues.
3. Following phenomenon should be avoided in the ducting installation.

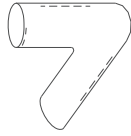

Severe bends

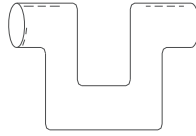

Multiple direction changes



Multiple reducers/ crimped duct

4. Excessive use of flex-duct and long flex-duct runs should be avoided.
5. Fire dampers must be fitted as per national and local fire regulations.
6. Unit must not be exposed to ambient temperature above 40°C and should not face an open fire.
7. Take action to avoid dew and frost.

As shown by drawing below, unit will produce dew or frost when saturation curve is formed from A to C. Use pre-heater to ensure conditions are kept to right of the curve (B to B'), to move C to C') to prevent condensation or frost formation.

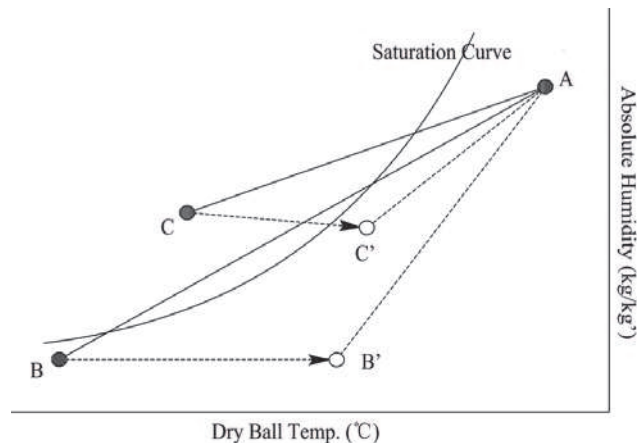

8. To avoid the outdoor exhaust air cycling back to indoor, the distance between the two vents installed on the outside wall should be over 1000mm.
9. If heater is equipped to the unit, operation of heater should be synchronous with the unit, so that the heater starts to work only when unit starts.
10. Duct muffler may be considered if user wants indoor noise to be minimized.

# Electrical Installation

## Warning

Power must be isolated during installation and before maintenance to avoid injury by electric shock. The specifications of cables must strictly match the requirements, otherwise it may cause performance failure and danger of electric shock or fire.

Power supply is AC220V/50HZ/1 Phase. Open the cover of electrical box, connect the 2 wires (L/N/) to the terminals and connect the cable of the control panel to the board according to the wiring diagram, and join the control panel to the cable.

Model	Spec. of power supply cable	Spec. of normal controller cable	Fuse
XHBQ-D2THA,XHBQ-D1.5TPA	3×1.5mm <sup>2</sup>	7×1mm <sup>2</sup>	3A
XHBQ-D3THA,XHBQ-D2.5TPA			
XHBQ-D4THA,XHBQ-D3.5TPA			
XHBQ-D6THA,XHBQ-D5TPA			
XHBQ-D8THA,XHBQ-D6.5TPA, XHBQ-D8TPA		8×1mm <sup>2</sup>	6A
XHBQ-D10THA,XHBQ-D10TPA			
XHBQ-D13THA,XHBQ-D15TPA,XHBQ-D20TPA			

## Warning

We do not accept any liability for any problems caused by the user's self and non-authorized re-engineering to the electrical and control systems.

Model	Capacitor		Power Supply	Control Panel Model
XHBQ-D2THA, XHBQ-D1.5TPA	1.5μF	450V AC	220V/1Ph/50Hz	HDK-08S
XHBQ-D2.5TPA	1.5μF	450V AC		
XHBQ-D4THA, XHBQ-D3.5TPA	3μF	450V AC		
XHBQ-D6THA, XHBQ-D5TPA	3.5μF	450V AC		
XHBQ-D6.5TPA	5μF	450V AC		
XHBQ-D8THA, XHBQ-D8TPA	8μF	450V AC		
XHBQ-D10THA, XHBQ-D10TPA	10μF	450V AC		
XHBQ-D13THA	7μF	450V AC		
XHBQ-D15TPA	8μF	450V AC		
XHBQ-D20TPA	10μF	450V AC		

# Wiring Diagrams

## XHBQ-D2THA to D6THA, XHBQ-D1.5TPA to D5TPA Models

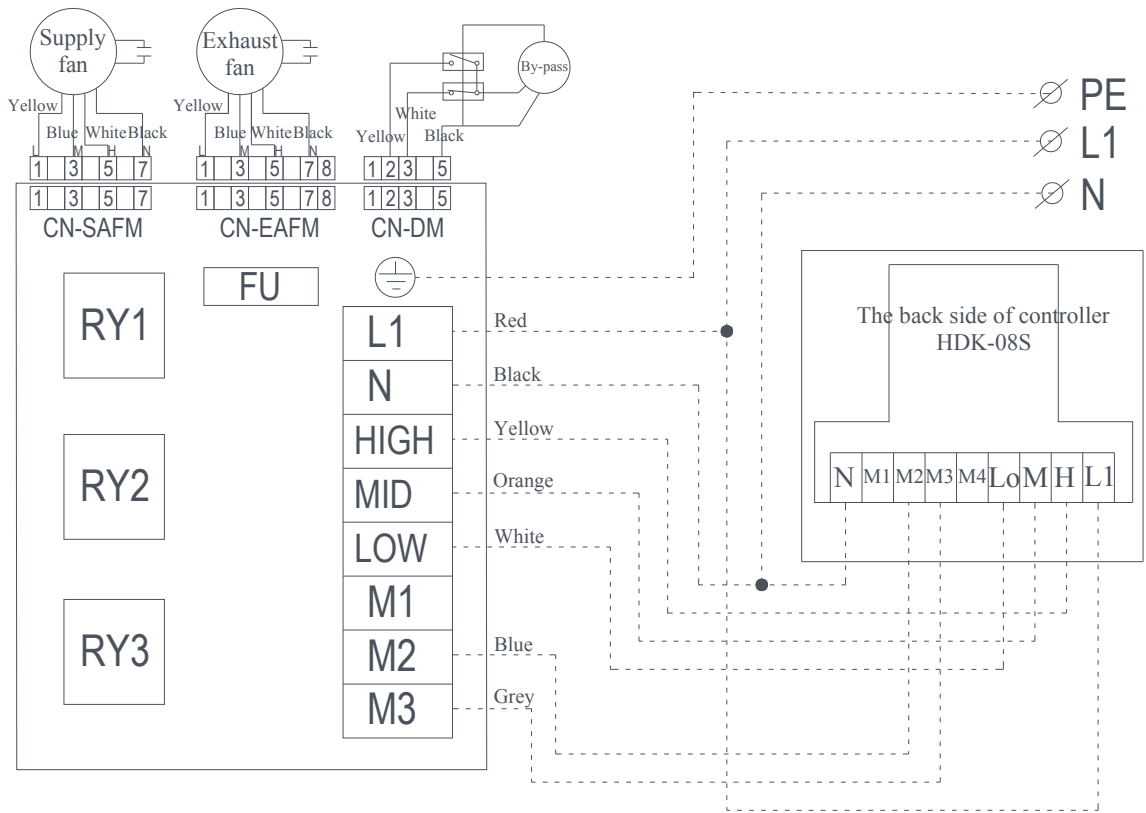

## XHBQ-D8THA to D13THA, XHBQ-D6.5TPA to D10TPA Models

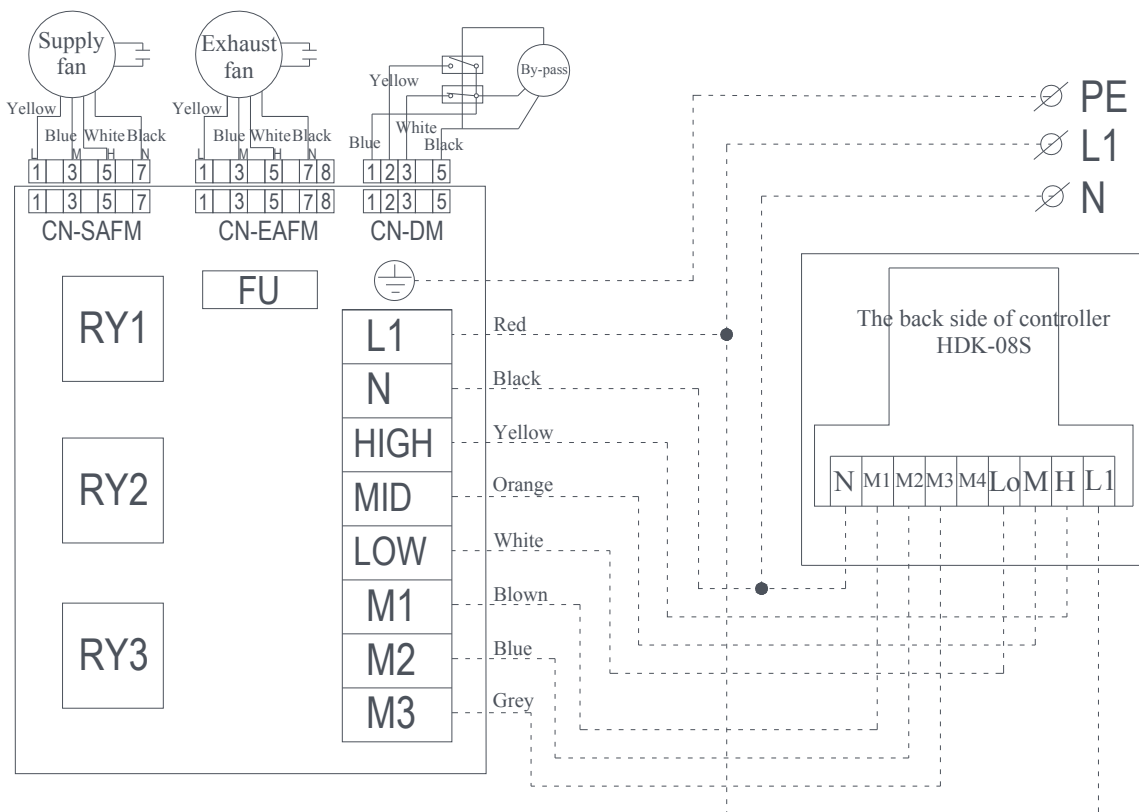

# Wiring Diagrams

## XHBQ-D15TPA to D20TPA Models

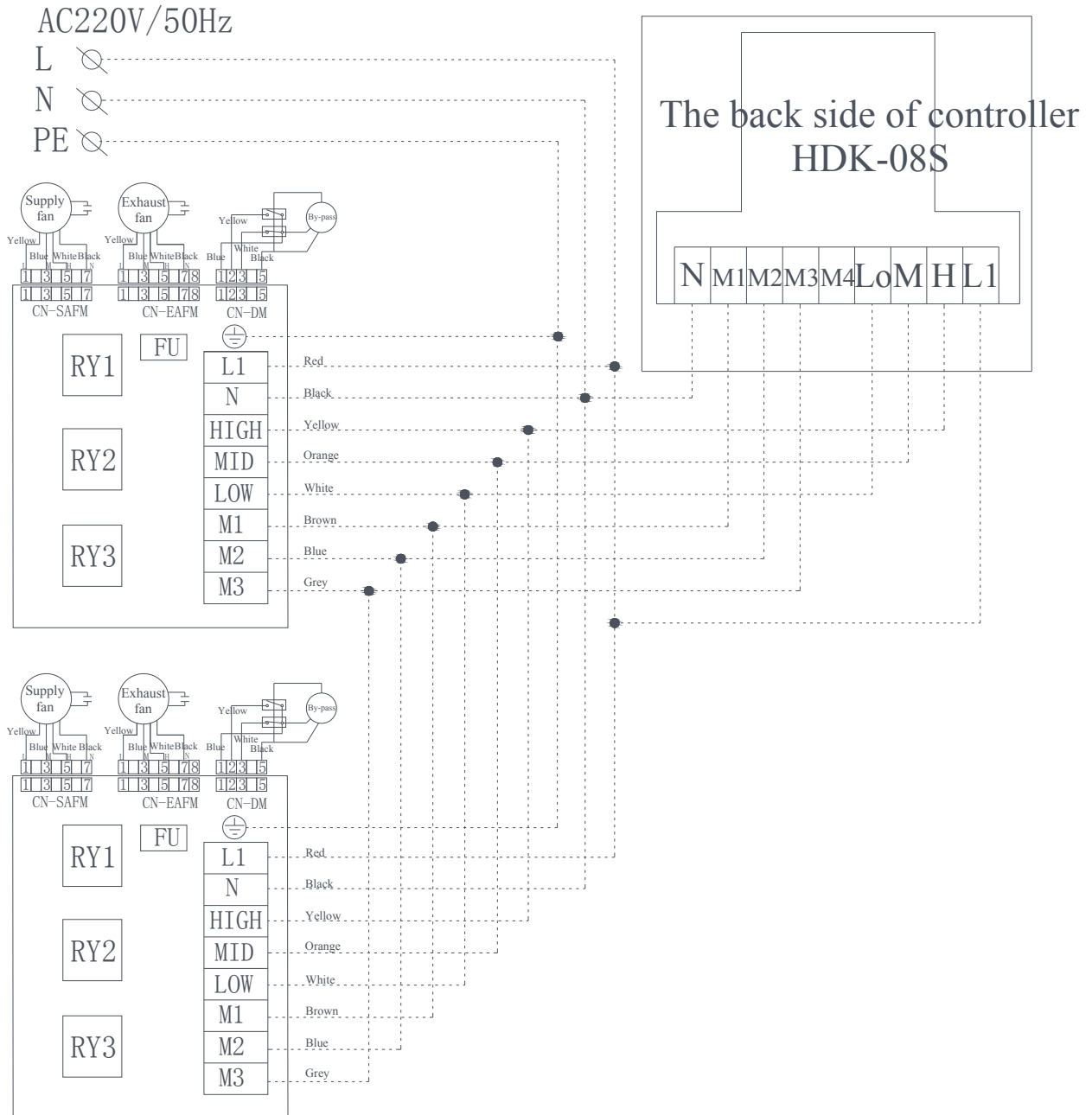



# Commissioning

1. After the installation, check that all cable sizes, circuit breakers and wire connections are correct before following below commissioning steps:

2. Press button  to turn on/off the ventilator.









3. Press button "M" to select the manual mode  or auto mode .

4. Under manual mode, press  to select high speed , middle speed , low speed , or off **OFF**.







5. Press button  until  or  flash to change bypass mode or energy recovery mode.

Attention: For XHBQ-D8THA, XHBQ-D10THA, XHBQ-13THA, XHBQ-D8TPA, XHBQ-D10TPA, XHBQ-D15TPA, XHBQ-D20TPA, the supply fan and exhausted fan will stop for several seconds when the bypass damper is moving





6. During the commissioning if any faults happen, user should shut down the power to check the system.

Switch status			Check points	
Power switch 	Function switch	Air speed switch 	Air supply status	Damper
press  to turn on ventilator, press again to turn off ventilator	Energy recovery 	High 	Check if the air speed of vents of supply air and return are HIGH or LOW	Damper moves outward
	By-pass 	Middle 		Damper moves inward
		Low 		

## Warning

	Loose or incorrect wiring connection can cause explosion or fire when the unit starts to work. Use only rated power voltage.		Don't put fingers or objects into vents of fresh air or exhaust air supply. Injury may be caused by the rotation of the impeller.
	Don't install, move or re-install the unit by yourself. Improper action may cause unit instability, electric shock or fire.		Don't change, disassemble or repair the unit by yourself. Improper action may cause electric shock or fire.
	Running the unit continuously in an abnormal status may cause failure, electric shock or fire.		Switch off the power and breaker when you clean the exchanger.

## Attention







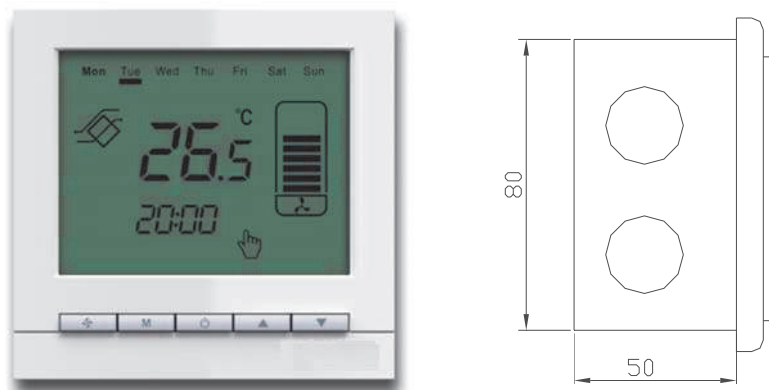





















	Don't site intake supply vent in hot and humid conditions, as it may cause failure, current leakage or fire.		Don't put any burner directly facing the fresh air discharge, otherwise it may cause an insufficient burning.
	Isolate power during extended off periods. Isolate power and take care when cleaning unit. (Risk of electric shock)		Observe guidelines and regulations relating to incomplete combustion when use is associated with fuel burning appliances.
	Clean the filter regularly. A blocked filter may result in poor indoor air quality.		

# Controller Introduction

HDK-08S controller is applied to control the heat recovery ventilator XHBQ-TPA, XHBQ-THA, XHBQ-TZA series, the equipment is fitted with supply fan and the extract fan, as well as a bypass device. ON/OFF function, speed conversion and the switch between normal ventilation and heat recovery ventilation can be operated by pressing the buttons on the controller. Standard controller cable is 1 meter long, user can extend the cable based on different project needs.



## Operation instructions

- ON/OFF: press button  once for starting; twice for closing. In ON status, the equipment begins to run. In OFF status, the ventilator stops operation but all settings are kept.
- Manual and Auto mode selection: in ON status, users can press button "M" to select the working mode, auto mode , manual mode 
- Three air velocity setting: Under manual mode, press button  to select the air velocity high, medium, low or off. Under auto mode, ventilator runs according to pre-setting fan speed, at this time press  to change fan speed.
- Bypass ventilation: press button  until  flashes, after 6 seconds enter the bypass mode  
Heat recovery ventilation: press the button  until  flashes, after 6 seconds enter the heat recovery mode.
- Bypass motor control: for the ventilator models which over 600CMH, when pressing  to change bypass mode  and heat recovery mode , the fan will stop running until bypass damper totally open or close, during this process, the  on the LCD will flash.
- Temperature adjustment: (Operate only under the condition of fault display)  
In the ventilator Off status, press the button "M" and  simultaneously for 2 seconds, until "XX °C" appears, press  or  to adjust to the right temperature, it will confirm in 6 seconds.
- Time setting: Press "M" for long until "hour" flashes, press  and  to adjust hour, then press "M" for short to change to "minute" or "week", press  and  to adjust minute and week.
- Filter alarm setting, press "M" and  for 2 seconds to enter filter alarm setting, at this time **SET** appear and  flashes, press  and  to set the time, setting range is 100 to 9900 hours, when filter alarms,  flashes, after changing the filter and cancel the alarm (press  and  for 2 seconds until  disappear), the timer will restart again.



# Controller Introduction

- days and 4 periods auto mode setting

- A. Press **+** and **▼** at the same time for 2 seconds, until "week" flash, at this time to press **▲** and **▼** to set week.
- B. Then press "M" button to confirm and enter "period" setting, at this time to press **▲** and **▼** to set period, or press button **+** to go back previous menu.
- C. Then press "M" button to confirm and enter "hour" setting, at this time to press **▲** and **▼** to set hour, or press button **+** to go back previous menu.
- D. Then press "M" button to confirm and enter "minute" setting, at this time to press **▲** and **▼** to set minute, or press button **+** to go back previous menu.
- E. Then press "M" button to confirm and enter "air volume" setting, at this time to press **▲** and **▼** to set air volume, or press button **+** to go back previous menu.
- F. Then press "M" button to confirm and return to week setting menu, then repeat 2.3.4.5 progress to complete the whole week setting.
- G. Reset to factory default setting: when ventilator is on, press button **+** and "M" button together for 2 seconds.

Attention:

- "M" button is confirm button while "**+**" is cancel button, when in auto mode setting, press **+** can escape 7 days and 4 periods setting, or without operation for 20 seconds, system will leave setting automatically.
- Under auto mode, press **+** can change fan speed.

## Default Auto mode period and fan speed setting

Week	Period	Air volume	Period	Air volume	Period	Air volume	Period	Air volume
Mon.	1	M	2	M	3	M	4	Off
	8:00		12:00		13:00		18:00	
Tue.	1	M	2	M	3	M	4	Off
	8:00		12:00		13:00		18:00	
Wed.	1	M	2	M	3	M	4	Off
	8:00		12:00		13:00		18:00	
Thu.	1	M	2	M	3	M	4	Off
	8:00		12:00		13:00		18:00	
Fri.	1	M	2	M	3	M	4	Off
	8:00		12:00		13:00		18:00	
Sat.	1	M	2	M	3	M	4	Off
	8:00		12:00		13:00		18:00	
Sun.	1	M	2	M	3	M	4	Off
	8:00		12:00		13:00		18:00	

# Maintenance

## Warning

Power must be isolated before installation and maintenance to avoid injury or electric shock. Supply power cables, main circuit breaker and earth leakage protection, must comply with national regulations. Failure to observe could cause unit failure, electric shock or fire.

Standard filtration is supplied with this unit and must be used. Dust and dirt can accumulate in the heat exchanger if filters are removed. (This can lead to failure or decreased performance). To ensure efficient operation, regular cleaning or replacement of filters is required. Filter maintenance frequency will depend on working environment and unit running time.

### Cleaning the filter

1. Open the access door
2. Remove the filters (from the side of the unit)
3. Vacuum the filters to get rid of the dust and dirt. For bad conditions dip it into water with soft wash to clean.
4. Push the filters to the positions after they get dried naturally, close the access door.
5. Change the filters if they are badly affected with dust and dirt or if they are broken.

### Maintenance of heat exchanger

1. Pull off the filters first
2. Draw out the exchanger from the unit
3. Establish a cleaner schedule to clean the dust and dirt on the exchanger.
4. Install the exchanger and filters to their positions and close the access door.

Remarks: It is recommended maintenance of the exchanger is made every 3 years

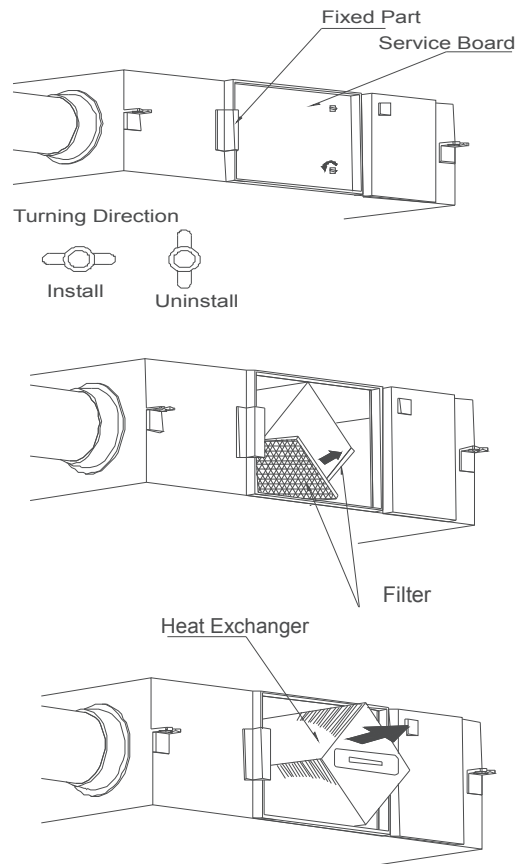

### Failure diagnose

User can use the unit after trial operation. Before contacting us, you can make self trouble shooting following below chart in case of any failure.

Phenomenon	Possible reason	Solutions
The airflow volumes both indoor and outdoor vents drop obviously after a period of operation.	Dust and dirt blocking the filter	Replace or clean the filter
Noise comes from vents	Vents installation are losing.	Re-tightening the vents connections
Unit doesn't work	<ol style="list-style-type: none"> <li>1. No electricity</li> <li>2. Protection breaker is cut</li> </ol>	<ol style="list-style-type: none"> <li>1. Guarantee power is on</li> <li>2. Connect the breaker</li> </ol>